

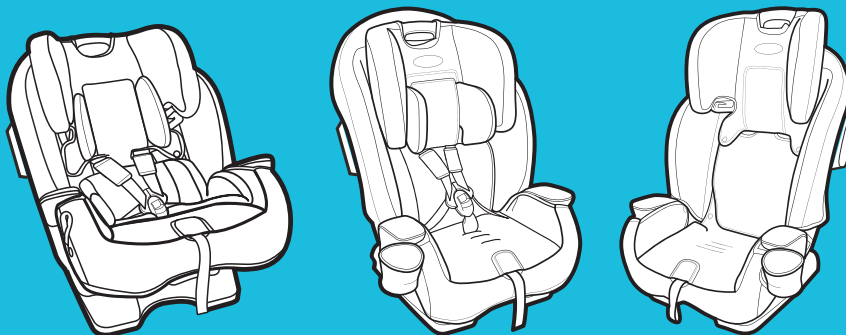

SLIMFIT™ LX

ALL-IN-ONE CHILD RESTRAINT SYSTEM
使用說明書 USER MANUAL



R41118

※適用體重於**2.5kg**以上，**36kg**以下的孩童。 ※符合歐洲ECE-R44／04安全標準認證。
※此汽車用兒童保護裝置僅適用符合CNS 3972或等效標準之3點式車輛安全帶之車輛座椅使用。
(無法使用2點式車輛安全帶)

注意：請務必在詳細閱讀及清楚理解本說明書的指示後，再安裝或使用本汽車用兒童保護裝置。
IMPORTANT - Please read the user manual before use and use this product correctly.

NWL0000982161E

目錄 Index

警告 Warning.....	2 ~ 6
各部位名稱 Parts list	7
孩童的乘坐條件 Riding condition for child.....	8
後向安裝 Rear-Facing	9
後向式-使用車用安全帶安裝 Install Rear-Facing With Vehicle Seat Belt	1 0 ~ 1 2
前向安裝 Forward-Facing	1 3
前向安裝方式 Install the Forward-Facing	1 4
前向式-使用ISOcatch安裝 Install Forward-Facing With ISOcatch System	1 5 ~ 1 7
前向式-使用車用安全帶安裝 Install Forward-Facing With Vehicle Seat Belt	1 8 ~ 2 0
讓孩童乘坐時 Place Your Child in the Seat	2 1
使用時的確認 Verification of use	2 2 ~ 2 4
輔助座椅模式 Booster Mode	2 5 ~ 2 6
輔助座椅的安裝方式 Install the Booster	2 7 ~ 3 0
讓孩童乘坐時 Place Your Child in the Seat	3 1 ~ 3 2
附屬配件 Accessories	3 3 ~ 3 4
選擇一個合適的車輛座椅位置 Choosing Vehicle Seat Location	3 5
危險的車輛座椅位置 Unsafe Vehicle Seat Locations	3 6 ~ 3 7
車輛安全帶的條件 Vehicle seat belt condition.....	3 8 ~ 3 9
安裝座椅條件 Conditions of vehicle seat.....	4 0
縫製品的拆卸方法 Disassembling method for sewing products	4 1 ~ 4 3
縫製品的清潔方式 Cleaning ways for Sewing product	4 4
平日保養 Standard maintenance/保管・廢棄方法 Custody・abandon method	4 5 ~ 4 6
保固事宜/適用車輛/MEMO/保證書	4 7 ~ 封底

警告 WARNING

請務必在使用本兒童保護裝置之前，先詳閱本說明書！

請將本說明書與兒童保護裝置放在一起，座椅靠背後方設有說明書收納處。由於攸關孩童的安全，請務必撥冗瞭解本兒童保護裝置的使用方式，並請特別注意紅字標示的警告訊息。

警告！家長及其他使用者請先詳細閱讀及瞭解本說明書之內容與自用車輛的車主手冊後，再安裝或使用本兒童保護裝置。

本產品為「通用型」及「半通用型」兒童保護裝置符合台灣CNS11497以及歐盟安全標準ECE R44.04。其適用大部分（並非全部）之車輛座椅。

此兒童保護裝置僅適用符合CNS 3972或等效標準之3點式車輛安全帶之車輛座椅使用。

嚴禁將本兒童保護裝置安裝於前座或配置有安全氣囊的座位上使用。

在安裝放置本兒童保護裝置時，應注意切勿讓汽車車門卡住兒童保護裝置的任何組件。

Read this User Manual completely BEFORE first use of your car seat!

Keep this User Manual always with the car seat. Provisions are made on the rear of the seat shell. Plan to spend some time getting to know your car seat-time well spent when you consider that your baby's safety depends on it. Pay special attention to the warnings, printed in red.

! WARNINGS to parents and other users. DO NOT INSTALL OR USE THIS CHILD RESTRAINT UNTIL YOU READ AND UNDERSTAND THE INSTRUCTIONS IN THIS MANUAL AND IN YOUR VEHICLE OWNER'S MANUAL.

This is a "Universal" or "semi-universal" child restraint system for vehicles and meets national standard CNS11497 of Taiwan, and European Standard ECE R44.04 It is applicable to most (not all) vehicle seats.

This child restraint system for vehicles is only suitable for car seats with 3-point seat belts that meets CNS 3972 or equivalent standard.

DO NOT use your car seat rear-facing on any passenger seat where an active frontal airbag is fitted.

Do take care so that the rigid items and plastic parts of the car seat must be so located and installed so that it is not liable to become trapped by a moveable seat or in a door of the vehicle.

警告 WARNING

車輛行進時，無論任何理由皆不得將孩童抱離本兒童保護裝置。若孩童哭鬧或需要安撫照料時，請先將車輛停在路邊安全的地方後再處理。

若長期不使用兒童保護裝置時，請將其收存於安全場所。切勿在本產品上放置重物。

請務必於每次使用前，檢查本兒童保護裝置的功能是否完好。

請定期檢查所有安全保護裝置是否有磨損。

在無人照料時，不得單獨將孩童留在兒童保護裝置內。

請將放置於車上的行李及其他物品確實固定好，以免緊急煞車或轉彎時，因物品滑動而導致嚴重傷害。物品體積越大，造成傷害的風險越高。

請勿自行改裝本兒童保護裝置或安全帶或加裝任何零組件。

請勿使用其他製造商提供之配件或零組件，以免兒童保護裝置無法發揮正常功用而導致嚴重傷亡。

DO NOT ever take a baby out of the car seat for any reason while vehicle is in motion. If your baby needs attention, find a safe place and pull off the road.

Do store your car seat in a safe place when not being used. Avoid putting heavy things on top of it.

Do always check the security of your car seat before each journey.

Do regularly check all child restraints for wear and tear.

DO NOT leave children unattended in your car, even for the shortest time.

DO NOT leave luggage and other objects unsecured in the car. If the car has to stop suddenly, these objects will continue moving and can cause serious injuries. The larger the object, the greater the risk.

DO NOT make unauthorized alterations or additions to any part of the seat or car seat belt.

DO NOT use accessories or parts supplied by other manufacturers. The function of the car seat could be altered, resulting in serious injury or death.

警告 WARNING

若本產品於意外中遭受劇烈撞擊，切勿繼續使用，應立即更換兒童安全座椅，意外可能導致產品無法提供完整的保護效果。

若有疑問，請洽兒童保護裝置進口商或供應商。

請勿使用非兒童保護裝置進口商在說明書中或座椅上指定的承載點。

重要！請務必依據進口商之指示，將汽車安全帶正確繞過兒童保護裝置以完成安裝。請務必拉直汽車安全帶與本產品的安全帶。

重要！若未正確使用本兒童保護裝置，將會提高急轉彎、緊急煞車或汽車碰撞時的嚴重傷亡風險。

若未正確安裝兒童保護裝置或孩童於乘坐時未正確繫妥安全帶，即使未發生碰撞事故，仍可能會因為緊急煞車與急轉彎而導致孩童受傷。

正確安裝及使用本兒童保護裝置攸關孩子的人身安全。

After an accident, the car seat must be replaced. You may not see any damage, but after a serious crash a car seat can be too weak to protect again.

Please contact child restraint manufacturer in the event of any questions.

DO NOT use load bearing points other than those specified by restraint manufacturer in the instructions or on the restraint body.

! IT IS MOST IMPORTANT that the child restraint is correctly installed with the vehicle belt correctly routed according to the manufacturer's instructions. Always ensure the vehicle belt and harness straps are not twisted.

! FAILURE TO PROPERLY USE THIS CHILD RESTRAINT INCREASES THE RISK OF SERIOUS INJURY OR DEATH IN A SHARP TURN, SUDDEN STOP OR CRASH. Your child can be injured in a vehicle even if you are not in a crash. Sudden braking and sharp turns can injure your child if the child restraint is not properly installed or if your child is not properly secured in the child restraint.

Your child's safety depends on you installing and using this child restraint correctly.

警告 WARNING

若未依據說明書和兒童保護裝置標籤的指示操作，可能會導致兒童在緊急煞車或碰撞事故中，因搖晃撞擊車輛而受傷。

沒有一張兒童保護裝置可以保證孩童在任何情況下能免受傷害，但正確地使用本兒童保護裝置的確可以在事故發生時減少重傷及死亡的危險。

即使您自認對此兒童保護裝置的使用方式瞭若指掌，仍強烈建議您詳細閱讀及瞭解本產品的使用說明書。

若需要任何協助，歡迎洽詢客服部門，我們將會竭誠地為您提供與零件、使用或維護問題有關的解答。

孩童的安全取決於：

1. 依據孩童的身型，選擇適合的頭部支撐位置。
2. 孩童已正確地坐在兒童保護裝置上。
3. 已在車上選擇合適的安全座椅位置。
4. 已正確將車輛安全帶繞過及固定兒童保護裝置。

Failure to follow these instructions and child restraint's labels can result in child striking the vehicle's interior during a sudden stop or crash.

No car seat can guarantee protection from injury in every situation, but proper use helps reduce the risk of serious injury or death.

Even if using this child restraint seems easy to figure out your own, it is very important to **READ, UNDERSTAND AND FOLLOW THE OWNER'S MANUAL.**

If you need help, please contact our Customer Service Department with any questions you may have concerning parts, use, or maintenance.

Your child's safety depends on:

1. Choose proper head support position based on your child's size.
2. Properly securing your child in the child restraint.
3. Selecting a suitable location for the child restraint in your vehicle.
4. Properly routing and securing the vehicle seat belt.

警告 WARNING

重要警告！

若車輛製造商在車主手冊中表示，該車適用此年齡層之「通用型」或「半通用型」兒童保護裝置時即可適用本產品於車輛之座椅。

切勿於椅套及縫製品未安裝的情況下使用本兒童保護裝置，椅套及縫製品為本產品束縛性能之整體構成要件。

請勿使用其他製造商的椅套。若需要更換零件，請洽詢您的 Graco 進口商。

切勿使用本說明書以外之任何組件安裝配置於本產品上。

請勿將本產品放置於日光直射之處。若金屬部位遇熱，恐讓使用者燙傷。將幼童放置在兒童保護裝置上前，請謹記先觸摸一下兒童保護裝置的金屬或塑膠部份，檢查兒童保護裝置的表面是否過熱。

請勿使用二手兒童保護裝置或來歷不明的兒童保護裝置。

IMPORTANT WARNING!

A correct fit is likely if the vehicle manufacturer has declared in the vehicle handbook that the vehicle is capable of accepting a "Universal" or "semi-universal" child restraint for this age group.

DO NOT use this child restraint system without having the soft goods properly installed, the soft goods are the required components in the child restraint system .

DO NOT use another manufacturers seat cover with this child restraint. See your retailer for Graco replacement parts only.

DO NOT use in any configuration not shown in the instructions.

THE CHILD RESTRAINT CAN BECOME VERY HOT IF LEFT IN THE SUN. Contact with these parts can burn your child's skin. Always touch the surface of any metal or plastic parts before putting your child in the child restraint.

NEVER USE A SECOND-HAND CRESTRRAINT or a child restraint whose history you do not know.

各部位名稱 Parts List

※本說明書所使用的插圖、組裝等，為求簡單明瞭，並非與實品完全相同。請以實際物品為主。
 ※For a concise approach, the images or assembly used in this User Manual may not be identical to the real product, so please check with the real product for reference.

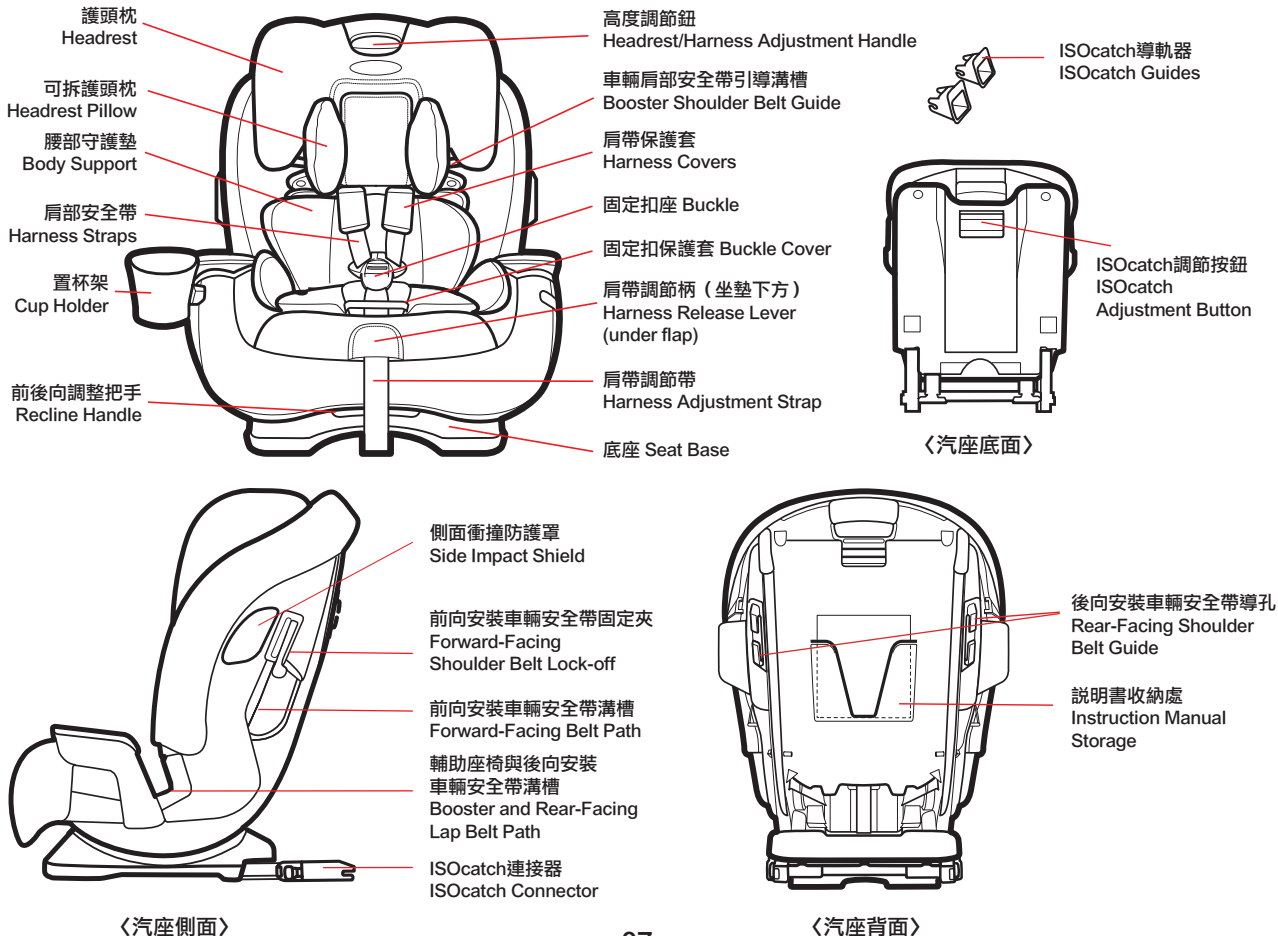

孩童的乘坐條件 Riding condition for child

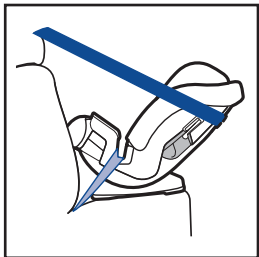

〔後向安裝 Rear-Facing 〕

質量等級0+ / 適用體重：0kg起～13kg以下

Group 0+ / Weight: from 0kg to 13kg

※體重未滿13公斤前，必須使用後向安裝。0-13 kg MUST be rear-facing.

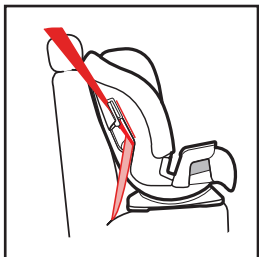

〔前向安裝 Forward-Facing 〕

質量等級 I / 適用體重：13kg以上～18kg以下

Group I / Weight: from 13kg to 18kg

※前向安裝勿提供2歲以下兒童乘坐，超過2歲兒童，仍宜盡量使用後向安裝。

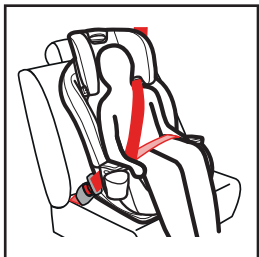

〔輔助座椅模式 Booster Mode 〕

質量等級 II、III / 適用體重：15kg以上～36kg以下

Group II、III / Weight: from 15kg to 36kg

※體重超過18公斤，必須使用輔助座椅模式。Over 18 kg MUST be in booster mode.

後向安裝 Rear-Facing

質量等級 0+

- 適用體重：0kg起~13kg以下
- 安全座椅必須採用後向安裝。
- 確實將汽車安全帶繞過後向安裝的安全帶溝槽（藍色標籤指示的部位）。
- 將安全座椅牢牢固定於汽車座椅上。
- 安全帶必須正好落在兒童肩膀之最高處或略低的位置。
- 安裝方式：車用三點式安全帶。

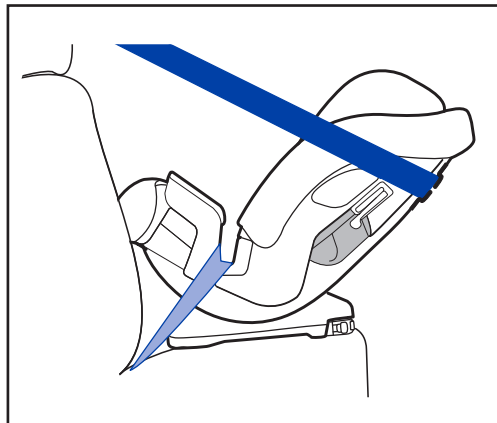

Group 0+

- Weight : from 0kg to 13kg
- Car seat must be rear-facing in the vehicle seat.
- Make sure vehicle seat belt is routed through the rear-facing belt path, marked with a blue label.
- Install this car seat tightly in your vehicle.
- Harness straps must be or just below the top of child's shoulders.
- Installation using 3-point belt only.

警告 **WARNING**

體重未滿13公斤的嬰幼兒必須採用後向安裝。
Infants who weigh less than 13kg **MUST** be rear-facing.

注意 **CAUTION**

寶寶肩膀高度未超過肩帶導孔最底位置時，請務必使用腰部守護墊。
Body support must be used if shoulders are below the lowest harness setting.

後向式-使用車用安全帶安裝 Install Rear-Facing With Vehicle Seat Belt

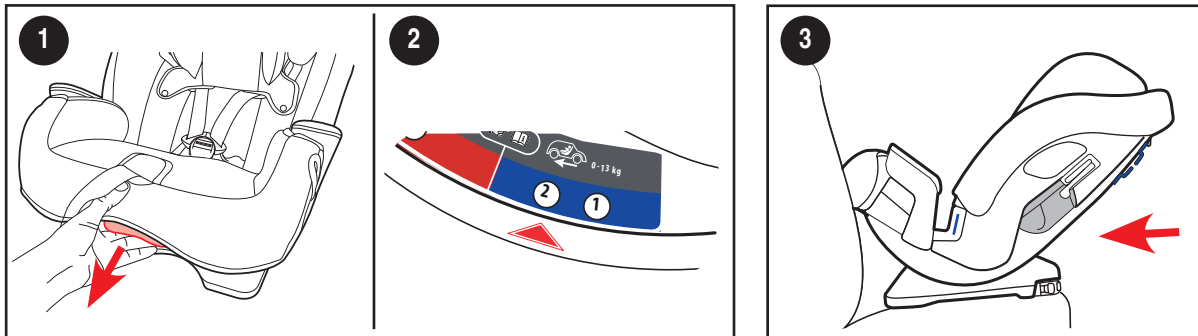

- 1 按壓座椅的前後向調整把手，調整座椅的傾斜角度。
Push the Recline Handle to recline the Car Seat.
- 2 將安全座椅傾斜角度調整至第 1 段或第 2 段的位置。
Place the car seat in recline position 1 or 2.
- 3 將底座平放在車輛座椅上，然後往後推直至安全座椅的前端碰到汽車座椅的椅背。
Place the base flat on the vehicle seat. Push it back until the front of the car seat touches the vehicle seat back.

警告 WARNING

- 操作調節動作時，請注意嬰幼兒的手或手指是否在周圍。因恐不慎夾到而導致受傷。
- 安裝座椅時，請注意靠背與主體間的空隙以及嬰幼兒的手或手指是否在周圍。因恐不慎夾到而導致受傷。
- Make sure child is clear from the seat when doing the operation in case child's hands or fingers may be pinched and get hurt.
- Pay attention when install a seat in which a child is already seated in case child's hands or fingers may be pinched and get hurt.

後向式-使用車用安全帶安裝 Install Rear-Facing With Vehicle Seat Belt

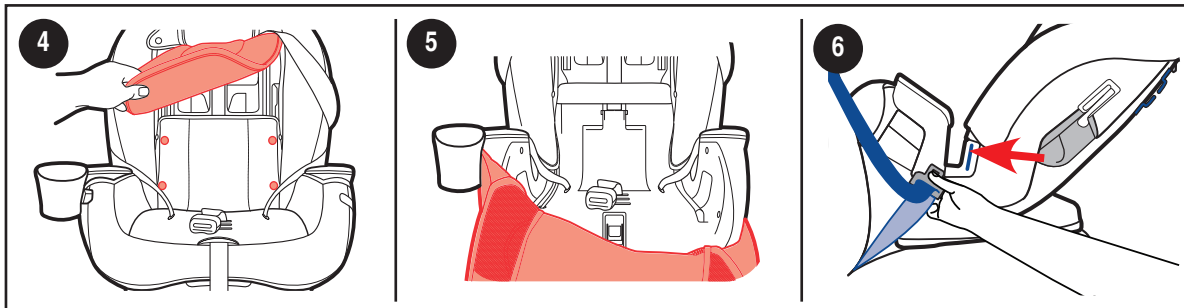

- ④ 解開安全座椅椅墊背面的固定扣(4處)。
Unsnap the pad from back (4 locations).
- ⑤ 將坐墊往前拉出至露出塑膠骨架結構。
Pull lower seat pad forward to expose the plastic shell.
- ⑥ 將汽車腰部安全帶穿過後向安全帶溝槽（藍色標籤指示的部位）後扣緊。
Thread vehicle lap seat belt through the rear-facing belt path (marked with a blue label) and buckle it.

⚠ 注意
CAUTION

- 確認安全帶順平沒有扭曲反折，並請確實將安全帶扣入相應的固定插扣。
The seat belt should lay as flat as possible and not be twisted. Make sure buckle and seat belt are in line with each other.



後向式-使用車用安全帶安裝 Install Rear-Facing With Vehicle Seat Belt

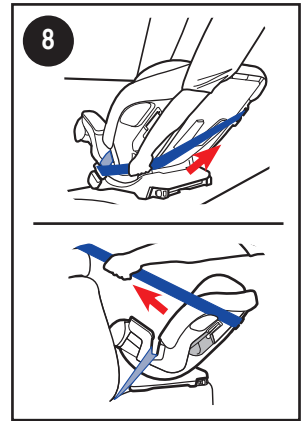
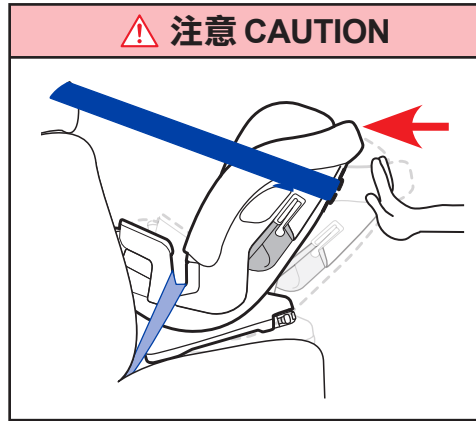
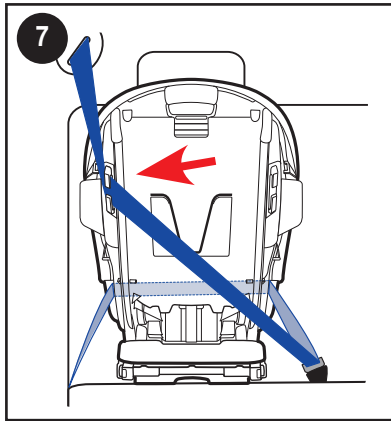

- ⑦ 將汽車肩部安全帶穿過座椅背面之藍色標籤指示的後向肩帶導向器。確認安全帶順平沒有扭曲反折。Thread the shoulder belt through the rear-facing shoulder belt guide on the back of the seat marked with blue labels. The seat belt should lay as flat as possible and not be twisted.

⚠ 注意 CAUTION

某些汽車安全帶可能於穿過安全座椅的椅背時長度略為不足，此時請先將座椅靠背向汽車座椅前傾(如圖示)，以利汽車安全帶繞過椅背嵌入肩帶導向器內，完成後再將安全座椅放回正確位置。

In case the seat belt is not long enough when installing the carseat, please lean the carseat toward the seat back so the seat belt can route through the seatbelt path on the carseat back completely, once buckled up, please restore the carseat position.

- ⑧ 拉緊汽車座椅的安全帶。確實朝安全座椅中央壓下，然後拉動收緊汽車肩部安全帶，將鬆動露出的安全帶收回捲收器中。
Tighten the Vehicle Seat Belt. Press down firmly in the center of the car seat. Pull on the shoulder belt to tighten while feeding the slack back in the retractor.

前向安裝 Forward-Facing

質量等級 I

- 適用體重：13kg以上～18kg以下，安全座椅必須採用前向安裝。
- 確實將汽車安全帶繞過前向安全帶溝槽（亮紅色標籤指示的部位）。
- 將安全座椅牢牢固定於汽車座椅上。
- 肩帶必須正好位於兒童的肩膀上或略高的位置。
- 安裝方式：
 - 1 · 車用三點式安全帶+ISOcatch。
 - 2 · 車用三點式安全帶。

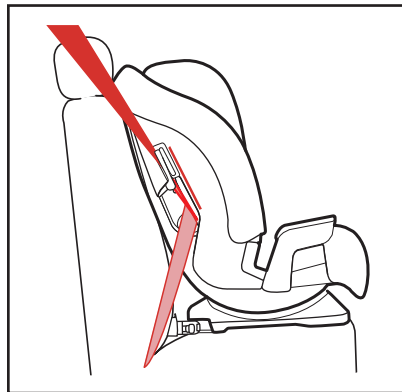

Group I

- Weight : from 13kg to 18kg, must be forward- facing in the vehicle seat.
- Make sure vehicle seat belt is routed through the forward-facing belt path, marked with a bright red label.
- Install this car seat tightly in your vehicle.
- Harness straps must be just above the child's shoulders.
- Installation using ISOcatch System and 3-point belt or using 3-point belt only.



- 若車輛無配備ISOFIX裝置時，請使用車用安全帶安裝，請參閱P18。
Please installation using 3-point belt if your car without ISOFIX system, See P18.

前向安裝方式 Install the Forward-Facing

【使用車用三點式安全帶+ISOCatch安裝 Installation using ISOCatch System and 3-point belt】

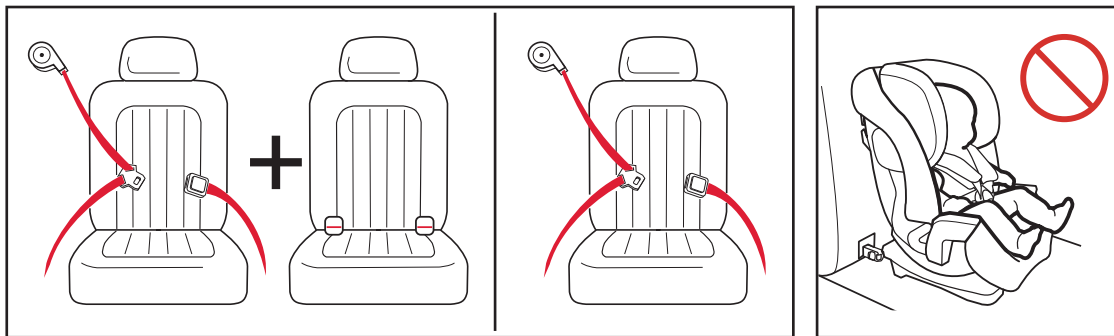

- 若您的汽車有配備ISOFIX裝置，在汽車座椅的下方折痕處可看見ISOFIX扣環，有關確切的位置、扣環標示與使用要求請參閱汽車手冊。
If vehicle is equipped with ISOFIX, the vehicle lower anchor points may be visible at the vehicle seat crease. See your vehicle owner's manual for exact locations, anchor identification, and requirements for use.
- 若您的汽車沒有配備ISOFIX裝置，請使用車用三點式安全帶安裝即可，請參閱P18。
If vehicle is equipped without ISOFIX, please installation using 3-point belt only, See P18.

 **警告**
WARNING

- 請勿僅使用ISOCatch安裝。
- Please do not install using ISOCatch System only.

前向式-使用ISOcatch安裝 Install Forward-Facing With ISOcatch System

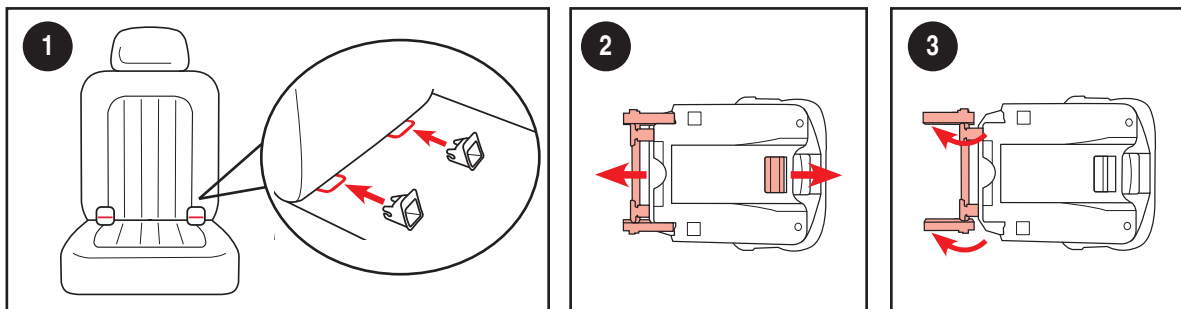

- ❶ 將ISOcatch導軌器插入ISOFIX扣環內進行安裝，ISOcatch導軌器可避免安裝時刮傷汽車座椅表面，同時可方便引導ISOcatch連結於ISOFIX扣環內。
Fit the ISOcatch guides with the ISOFIX anchor points. The ISOcatch guides can protect the surface of the vehicle seat from being torn. They can also guide the ISOcatch connectors.
- ❷ 按ISOcatch調節按鈕以拉出ISOcatch連接器。
Press the ISOcatch adjusting button to pull out the ISOcatch connectors.
- ❸ 將ISOcatch連接器旋轉180度，直到它們指向ISOcatch導軌器的方向。
Rotate the ISOcatch connectors by 180 degrees until they are pointing in the direction of the ISOcatch guides.

警告 WARNING

- 若車輛無配備ISOFIX裝置時，請使用車用安全帶安裝，請參閱P18。
Please installation using 3-point belt if your car without ISOFIX system, See P18.
- 安裝時請注意避免夾傷手指等部位。
Careful not to hurt finger during installation.

前向式-使用ISOcatch安裝 Install Forward-Facing With ISOcatch System

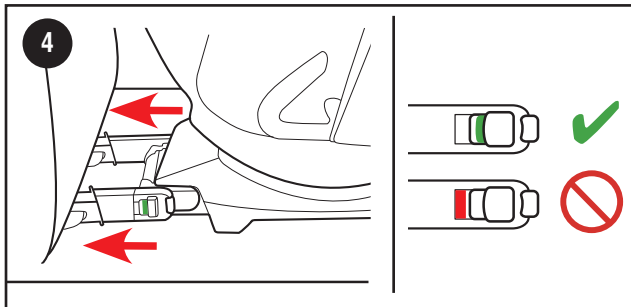

- ④ 將ISOcatch連接器與ISOFIX扣環對準後，將ISOcatch連接器用力推入ISOFIX扣環中。
Line up the ISOcatch connectors with the ISOFIX anchor points, and then click both ISOcatch connectors into the ISOFIX anchor points.
- 確任兩側ISOcatch連接器牢固地連接到其ISOFIX扣環。兩個ISOcatch連接器上的指示貼紙顏色應顯示為完全綠色。
Make sure that both ISOcatch connectors are securely attached to their ISOFIX anchor points. The colors of the indicators on both ISOcatch connectors should be completely green.
 - 通過拉動兩個ISOcatch連接器，檢查以確保兒童保護裝置已牢固安裝。
Check to make sure the child restraint is securely installed by pulling on the both ISOcatch connectors.

前向式-使用ISOcatch安裝 Install Forward-Facing With ISOcatch System

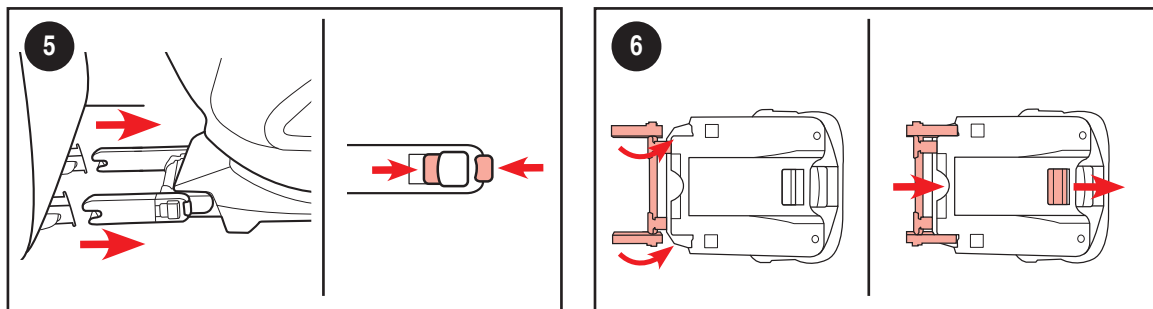

〈解除ISOcatch裝置 To remove the ISOcatch〉

- ⑤ 首先按下鎖定按鈕，再按下ISOcatch連接器上的按鈕，然後從車輛座椅上取下兒童保護裝置。

Press the secondary lock button first and then the button on the ISOcatch connectors before removing the child restraint from the vehicle seat.

- ⑥ 將ISOcatch連接器旋轉180度向內，按ISOcatch調節按鈕將ISOcatch連結器摺疊收納。

Rotate the ISOcatch connectors by 180 degrees, then press the ISOcatch adjusting button to fold the ISOcatch connectors.

前向式-使用車用安全帶安裝 Install Forward-Facing With Vehicle Seat Belt

【車用三點式安全帶安裝 Installation using 3-point belt】

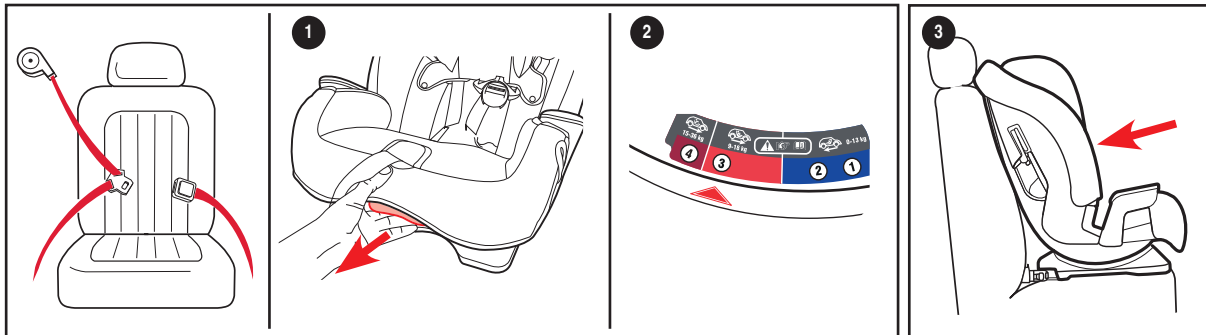

- 1 按壓座椅的前後向調整把手，調整座椅的傾斜角度。
Push the Recline Handle to recline the Car Seat.
- 2 將安全座椅傾斜角度調整至第3 段的位置。
Place the car seat in recline position 3.
- 3 將底座平放在車輛座椅上，然後往後推，直至安全座椅的背面碰到汽車座椅的椅背。
Place the base flat on the vehicle seat. Push it back firmly until the back of the car seat touches the vehicle seat back.

警告 WARNING

- 請先進行ISOcatch安裝後再務必進行車用三點式安全帶安裝，以完成安裝。
Please install using ISOcatch System first then installation using 3-point belt to complete the installation.
- 請務必確認車輛座椅與安全座椅的靠背之間隙盡可能縮到最小。
Please make sure to diminish the gap between the backrest of the device and the backrest of vehicle seat.

前向式-使用車用安全帶安裝 Install Forward-Facing With Vehicle Seat Belt

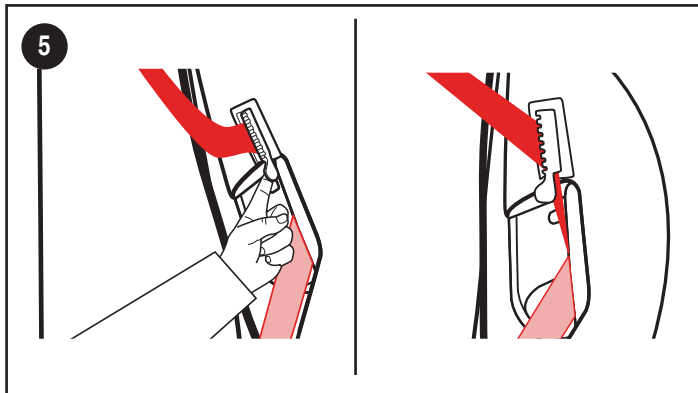
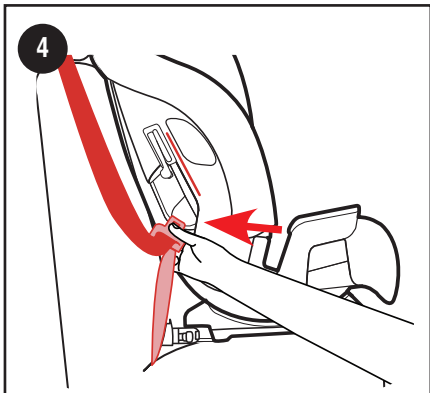

- ④ 將汽車安全帶穿過前向安全帶溝槽（紅色標籤指示處）後扣緊，確實將安全帶扣入相應的固定插扣，確認安全帶順平沒有扭曲反折。

Thread vehicle seat belt through the forward-facing belt path (marked with an bright red label) and buckle it. Make sure buckle and seat belt are in line with each other. The seat belt should lay as flat as possible and not be twisted.

- ⑤ 打開安全帶固定夾（如圖所示），將汽車肩部安全帶穿入兒童保護裝置側面的安全帶固定夾。

Open tab on shoulder belt lock-off as shown. Insert shoulder seat belt into shoulder belt lock-off on side of child restraint.

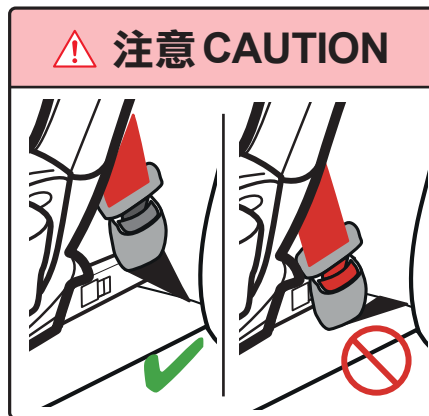

前向式-使用車用安全帶安裝 Install Forward-Facing With Vehicle Seat Belt

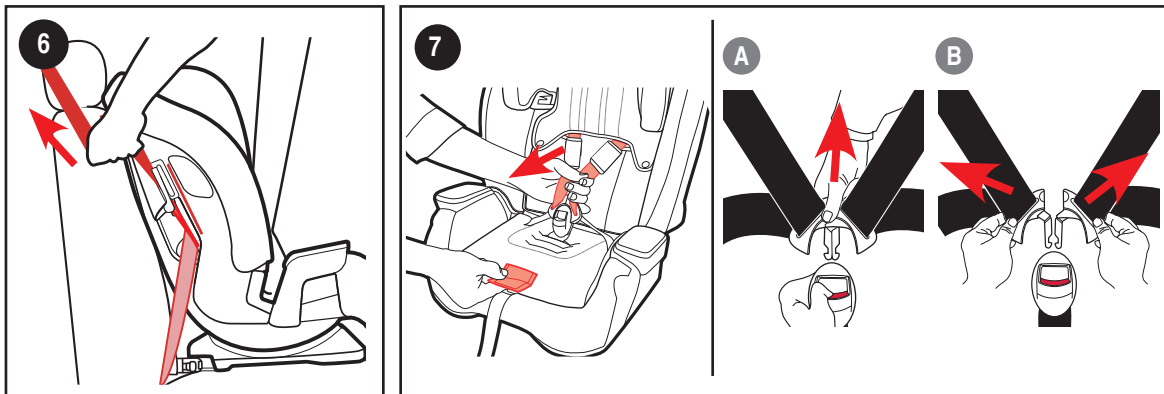

- ⑥ 確實朝安全座椅中央壓下，然後將汽車肩部安全帶往上拉以收緊。

Press down firmly in the center of the car seat. Pull on the shoulder belt to tighten.

- ⑦ 按下肩帶調節柄同時將肩部安全帶拉鬆。

Lift up on the harness release lever while pulling out on the harness straps

〈解開安全帶固定扣 Loosen Harness Straps〉

- ① 按壓固定扣解除扭。

Unbuckle the buckle .

- ② 將肩帶向外攤開。

Place harness straps off to the sides.

讓孩童乘坐時 Place Your Child in the Seat

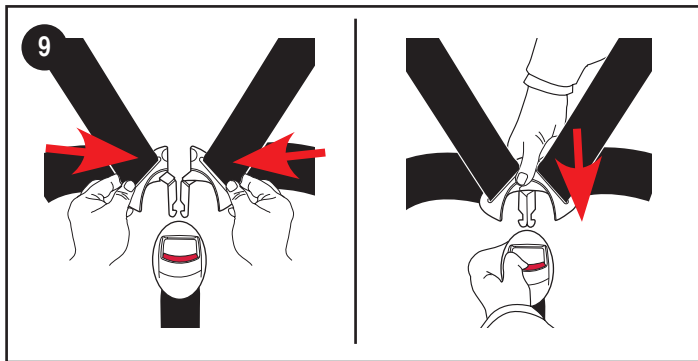
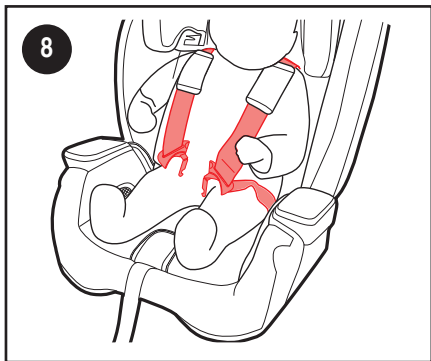

- ⑧ 將孩童的左右手分別穿過兩邊的肩帶。請確定孩童的背部平貼於安全座椅的椅面。

Place Harness Straps Over Child's Shoulders Make sure their back is flat against the car seat back.

〈固定五點式安全帶 Buckle Harness Straps〉

- ⑨ 組合左右安全帶固定扣，扣入固定扣座中，直到聽到「喀嗒」聲，拉扯安全帶確定已確實扣緊。

You will hear a "click" when buckle tongues are securely attached. Pull up on each buckle tongue to make sure it is securely attached.

使用時的確認 Verification of use

〈後向安裝 Rear-Facing〉

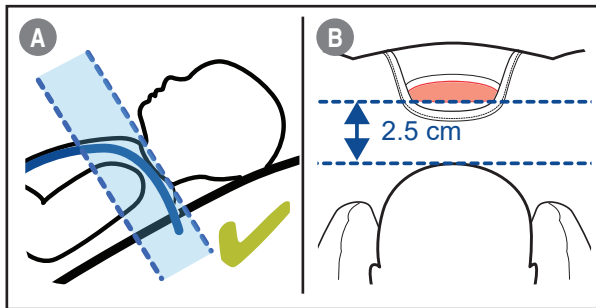

〈前向安裝 Forward-Facing〉

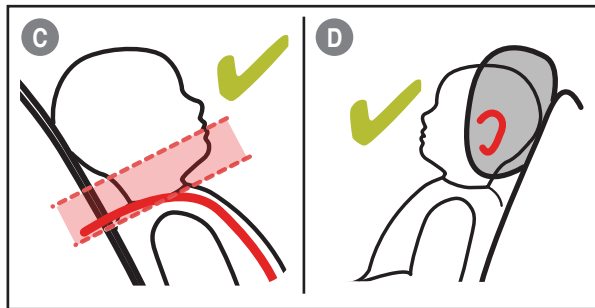

確認肩帶正確高度 Verification of Harness Straps Height

〈後向安裝 Rear-Facing:〉

- Ⓐ 肩帶必須正好位於孩童的肩膀或略低的位置。
Harness straps must be at or just below the child's shoulders.
- Ⓑ 頭頂必須至少距離高度調節鈕紅色 2.5 公分以上。
Top of head must be at least 2.5 cm below the red headrest/harness adjustment handle.

〈前向安裝 Forward-Facing:〉

- Ⓒ 肩帶必須正好位於孩童的肩膀或略高的的位置。
Harness straps must be at or just above the child's shoulders.
- Ⓓ 孩童的耳上必須低於頭枕頂部。
Top of child's ears must be below top of headrest.

使用時的確認 Verification of use

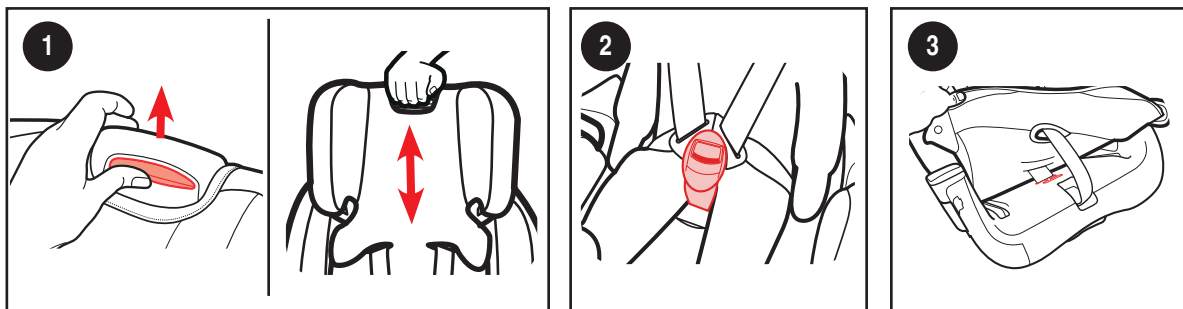

〈調整肩帶高度 Adjust the Harness Straps Height〉

- 1 按壓紅色高度調節鈕，將頭枕往上或往下移動，即可調整至需要的肩帶高度。
Squeeze the red adjustment handle and move headrest up or down for the proper harness height.

〈檢查固定扣的位置 Check the Buckle Position〉

- 2 固定扣座正確的位置為最靠近孩童股部卻沒有壓迫到孩童之股帶導孔。
The correct slot is the one that is closest to your child without being underneath them.
- 3 若需要調整股帶位置時，請從安全座椅正面掀起座布椅墊後，將可看見固定扣座的調整卡槽。
To Adjust, Lift the Lower Seat Pad From Front of Car Seat to Expose The Buckle Slots.

使用時的確認 Verification of use

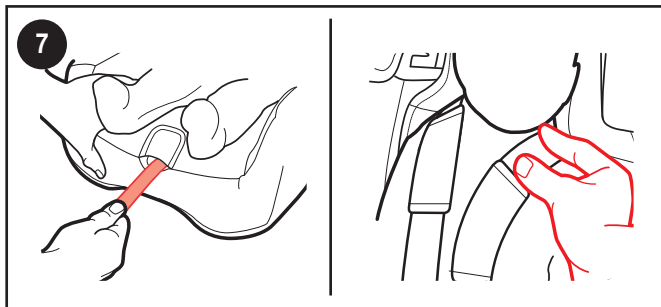
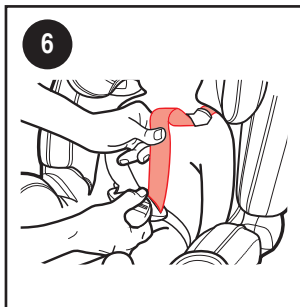

- ⑥ 從腰部拉出鬆弛的安全帶，將兩邊的肩帶往上拉以收緊。
Pull All the Slack Out From around the Waist, Pull up on the harness strap. Do this to both sides.
- ⑦ 拉緊調節帶以收緊肩帶，當無法再收緊孩童肩膀的任何一邊肩帶時，表示肩帶已完全收緊。
Tighten the Harness by Pulling the Harness Adjustment Strap, When you are not able to pinch any of the harness webbing at your child's shoulder, the harness is tight enough.

警告 WARNING

- 將安全帶固定扣扣入固定扣座時，請注意手指或手是否在周圍。因恐不慎夾到而導致受傷。
- 將安全帶固定扣扣入固定扣座時，若無發出「喀嚓」聲，不可使用。否則當發生碰撞等情況時，將無法充分發揮性能。
- When buckling up the seat belt, please watch out for fingers or hand position to avoid pinching or getting hurt.
- When buckling up the seat belt, stop using it if there is no “click” sound, otherwise it may not be able to fulfill its functions when a collision happens.

輔助座椅模式 Booster Mode

質量等級 II、III

- 適用體重：15kg以上～36kg以下
- 安全座椅必須採用前向安裝。
- 以輔助座椅模式使用時，請取下新生兒保護墊。
- 扣上汽車安全帶時，安全帶必須平貼孩童的身體，絕對不可以扭曲。
- 請確定汽車肩部安全帶位置，務必介於孩童脖子與肩膀外側邊緣的中間。
- 安裝方式：
 - 1 · 車用三點式安全帶+ISOcatch。
 - 2 · 車用三點式安全帶。

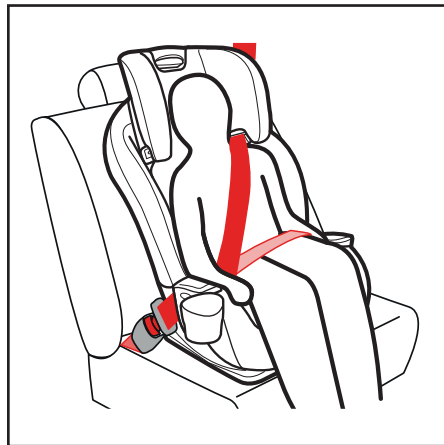

Group II、III

- Weight : from 15kg to 36kg
- Car seat must be forward-facing in the vehicle seat.
- Remove infant wedge when used as a booster.
- Vehicle seat belts MUST flat against child and MUST NOT be twisted.
- Make sure vehicle seat's shoulder belt is centered between the child's neck and edge of shoulder.
- Installation using ISOcatch System and 3-point belt or using 3-point belt only.



體重超過18公斤，必須使用輔助座椅模式。
Over 18 kg MUST be in booster mode.

輔助座椅模式 Booster Mode

⚠ 注意 CAUTION



- 切勿單獨使用汽車腰部安全帶固定孩童的身體。
- 車輛安全帶必須平放在兒童身上，不得扭曲。確保汽車肩安全帶位於兒童頸部和肩部邊緣之間的中心位置。
- 請勿將汽車的肩部安全帶置於孩童的手臂後方或背部。
- 務必讓坐在孩童保護裝置上之孩童的身體能貼穩座椅的靠背，以避免滑落。
- 請勿將汽車安全帶套掛在安全座椅的扶手上。
- 請勿讓孩童在安全座椅上滑動。

- Never use a vehicle lap only seat belt across front of child.
- A Vehicle seat belts **MUST** lay flat against child and **MUST NOT** be twisted. Make sure vehicle seat's shoulder belt is centered between the child's neck and edge of shoulder.
- **DO NOT** position vehicle shoulder belt under the child's arm or back.
- **DO NOT** allow child to slouch or slide down in the booster
- **DO NOT** position vehicle seat belt over top of armrests.
- **DO NOT** allow child to slouch or slide down in the booster seat.

輔助座椅的安裝方式 Install the Booster

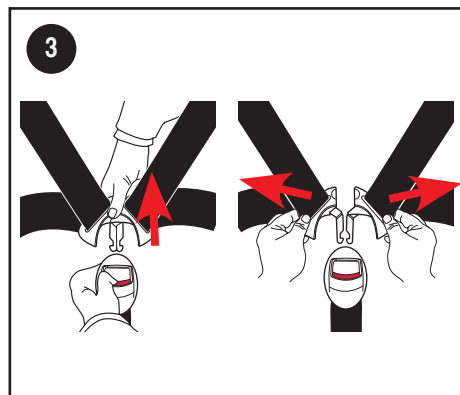
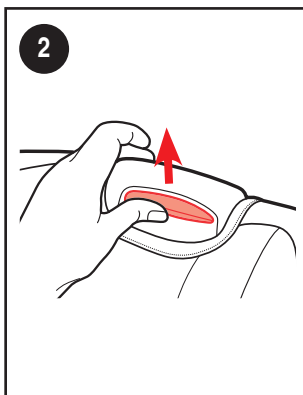
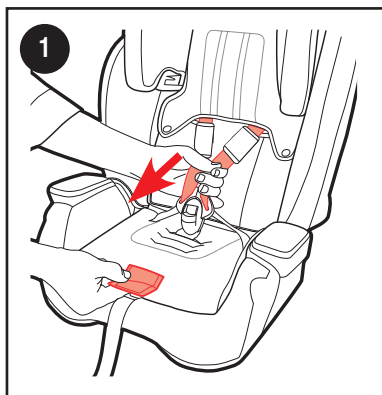

〈收納肩部安全帶 Loosen Harness Straps〉

- ❶ 盡可能將肩部安全帶拉鬆。
Loosen the harness straps as much as possible.
- ❷ 將頭枕抬至最高位置。
Raise the headrest to the highest position.
- ❸ 解開固定扣。
Unbuckle the buckle.



建議 Tips

僅需要拉肩部安全帶，務必避開肩部保護墊。

Only need to pull out harness strap, and need to stay away from harness covers.

輔助座椅的安裝方式 Install the Booster

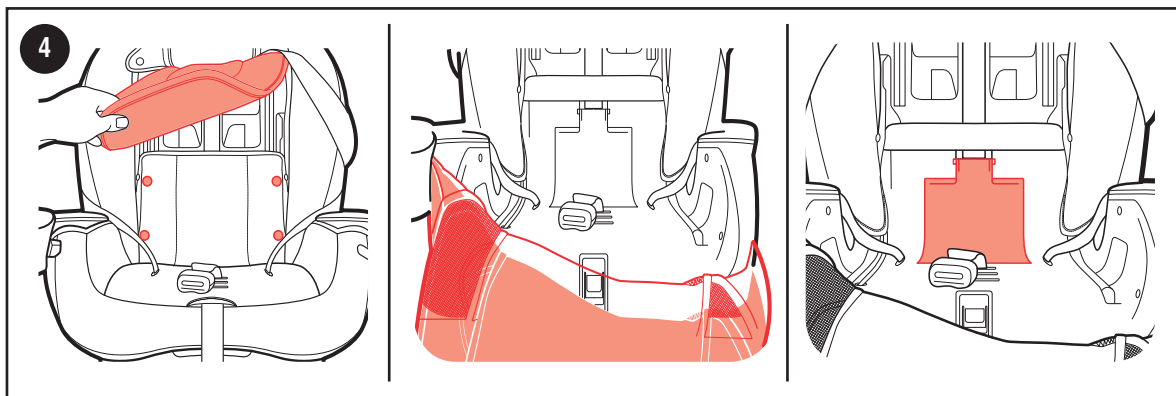

④取下座椅縫製品，打開五點式安全帶收納槽的蓋板。

Remove the Lower Seat Pad to Expose the Harness Storage Door.



建議 **Tips**

先將固定扣保護套取下之後會更方便操作。

It is more convenient to operate after removing the Buckle Cover.

輔助座椅的安裝方式 Install the Booster

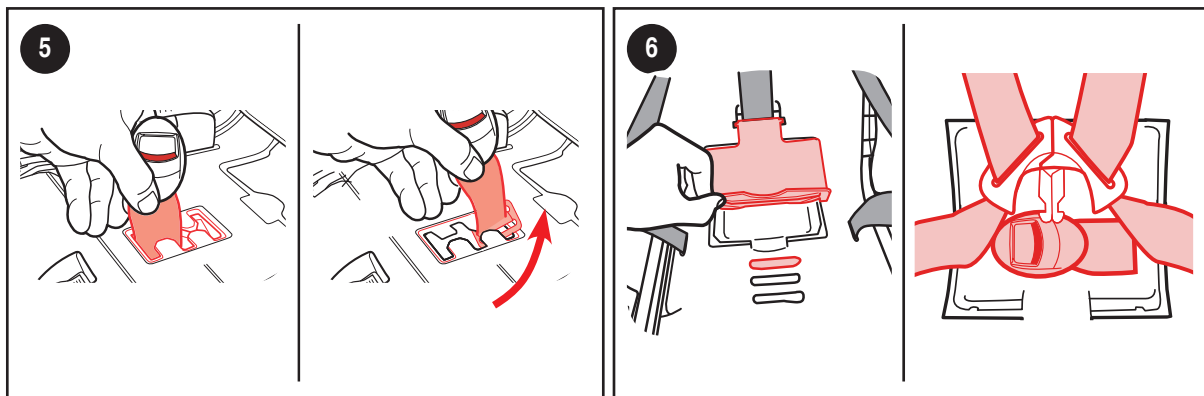

〈取下固定扣座 Remove Buckle〉

- ⑤ 扭轉股帶與固定槽垂直(如圖)，將固定金屬片向上轉，穿過椅殼，再由正面拉出股帶固定扣。
Twist the crotch belt as shown. Rotate the metal retainer up through the shell. From the front, pull the crotch buckle out.
- ⑥ 打開五點式安全帶收納槽的蓋板，將肩帶、固定扣座放入收納槽中，關上收納槽蓋板。
Open the Harness Storage Door and Place Harness, Buckle, and Buckle Tongues Inside Storage Compartment. Close the Door.

輔助座椅的安裝方式 Install the Booster

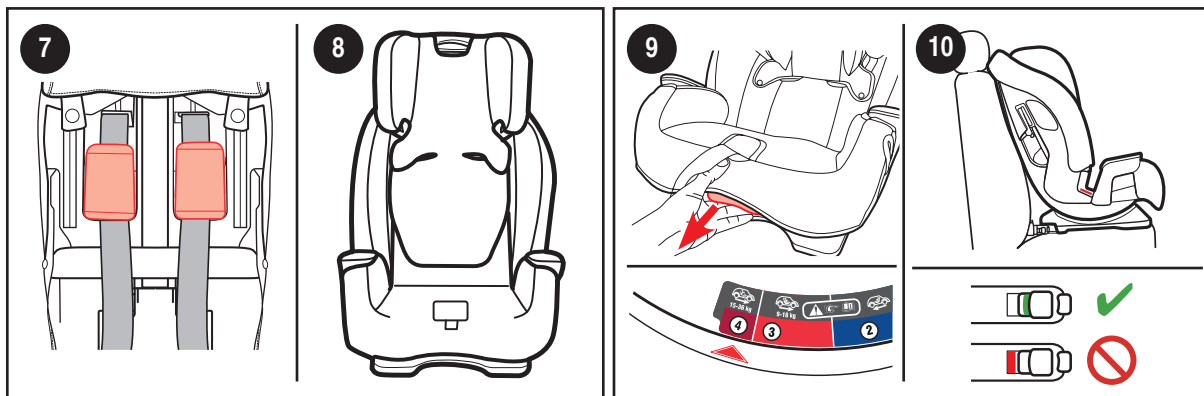

〈收納肩帶保護套 Store Harness Covers〉

- 將肩帶保護套收進椅背上的凹槽開口部位（如圖所示）。
Place the harness covers in the shell back openings as shown.
- 裝回椅墊，將護頭枕調整至適合孩童的位置。
Replace Seat Pad, Move the headrest back to its proper position for your child.
- 調整座椅的傾斜角度，將安全座椅調整至第 4 段的位置。
Recline the Car Seat, Place the booster seat in recline position 4.
- 前向安裝於車輛時，請先進行ISOcatch安裝，安裝方式請參閱P14~P16。
Place the Booster Seat Forward-Facing in the Vehicle Seat Installation with ISOcatch attachment is as P14~P16.

讓孩童乘坐時 Place Your Child in the Seat

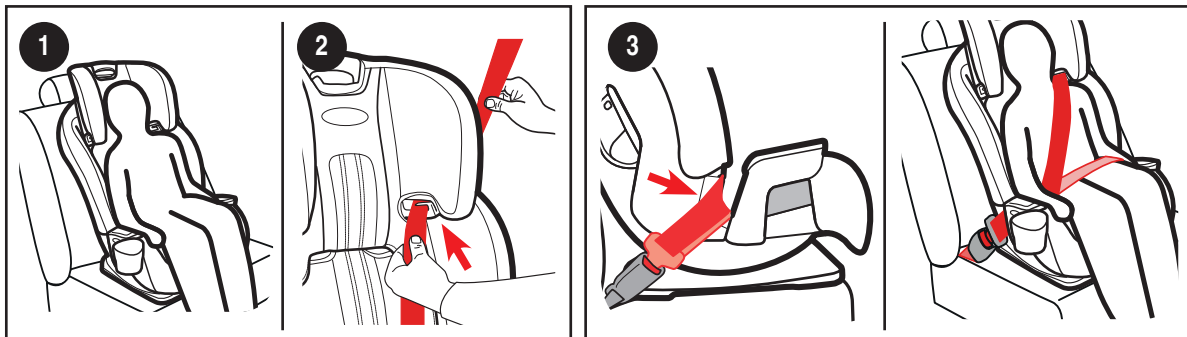

❶ 孩童乘坐時請將背部平貼座椅靠墊。

Have your child sit in the booster seat, with their back flat against the back of the booster seat.

❷ 將汽車的肩部安全帶穿過車輛肩部安全帶引導溝槽。

Thread Vehicle's Shoulder Belt Through Booster Shoulder Belt Guide in the Headrest

❸ 請確定汽車的腰部安全帶及肩部安全帶穿過車輛安全帶溝槽（深紅色標籤指示的部位），且確實扣入安全帶扣中。

Be sure the lap portion of the vehicle seat belt goes behind the armrests marked with a dark red label. Both the lap and shoulder belt must lay in the booster belt path on the buckle side of the seat marked with a dark red label.

讓孩童乘坐時 Place Your Child in the Seat

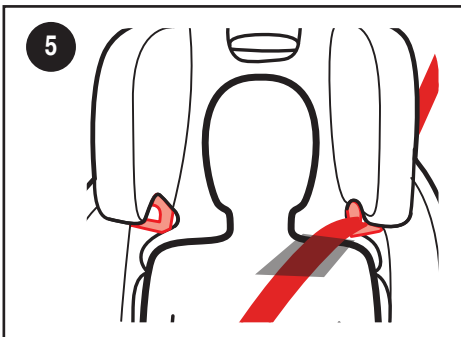
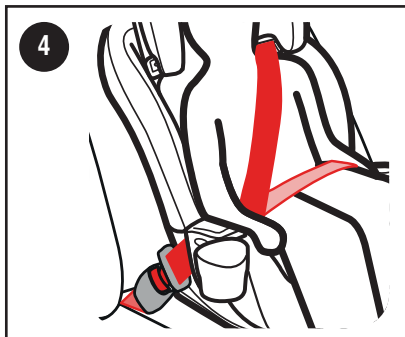

- ④繫上汽車腰部安全帶，應讓汽車腰部安全帶低於孩童的骨盆位置，並調整至服貼程度。

Be sure the lap portion of the vehicle seat belt is low across your child's hips and is adjusted snugly.

- ⑤汽車肩部安全帶，應介於孩童脖子與肩膀外緣之間。

Vehicle seat's shoulder belt should be centered between the child's neck and edge of shoulder.

※請調整頭枕高度，以達到理想的肩部安全帶位置。

Raise or lower the headrest to change the shoulder belt location on the child.

警告 WARNING

• 肩部安全帶、腰部安全帶不可有鬆弛及反折的現象，腰部安全帶不可置放於骨盆上以外的地方。當操作或使用錯誤時，極有可能造成孩童死亡或重傷。

Reversely folded situation is not allowed on shoulder belt and waist belt. Waist belt should not be placed on a position other than the pelvis. If operated or used with mistake, it may cause the child death or serious injury.

附屬配件 Accessories

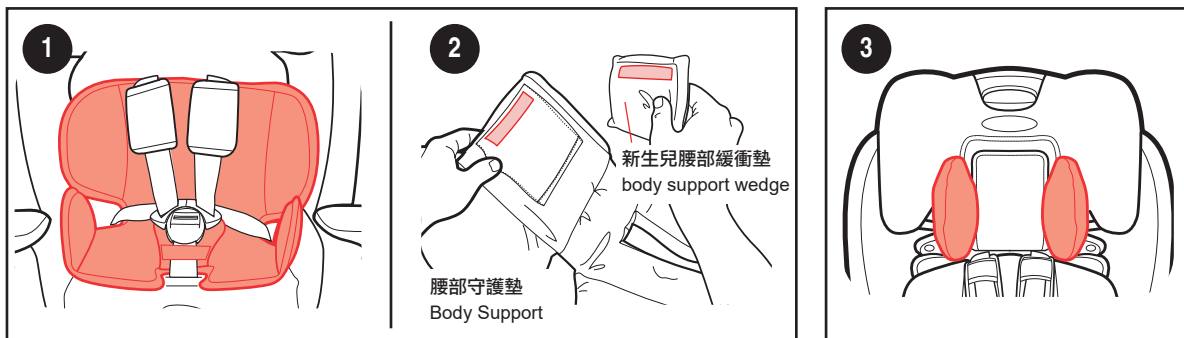

❶ 〈腰部守護墊 Body Support〉

若肩膀低於肩帶的最低設定時，必須使用腰部守護墊。若不使用時，請解開五點式固定扣，即可取出腰部守護墊。

Body support must be used if shoulders are below the lowest harness setting. To remove, unbuckle the buckle and pull out the body support.

❷ 體重未滿5公斤的新生兒，請使用新生兒腰部緩衝墊，體重超過5公斤以上的嬰幼兒，請拆下新生兒腰部緩衝墊。

For infants 0-5 kg, use the body support wedge. Remove the wedge for infants over 5 kg.

❸ 〈可拆護頭枕 Headrest Pillow〉

若不使用時，請取下可拆護頭枕，將其拉出即可。

To remove, pull out the pillow out.

附屬配件 Accessories

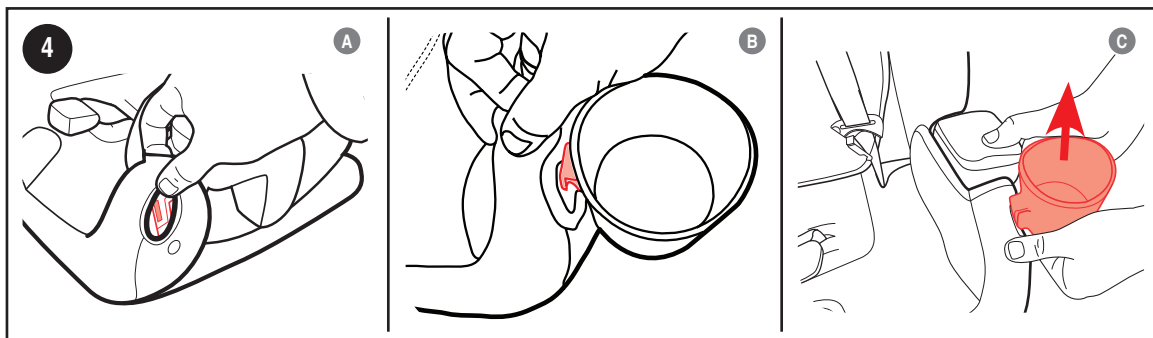

4 <置杯架 Cup Holder>

置杯架可安裝於左右任一側。

Cup holder can be on either side.

Ⓐ 安裝時，請先調整椅墊至露出安裝插孔。

To attach, pull back the seat pad to expose the attachment guide.

Ⓑ 將置杯架插入安裝插孔至定位為止。

Slide the cup holder down the guide until it locks into place.

Ⓒ 不使用時，請將雙手放置杯架下方，將置杯架往上推出即可。

To remove, place both hands under the cup holder and push up on the cup holder.

選擇一個合適的車輛座椅位置 Choosing Vehicle Seat Location

- 請詳閱車主手冊，瞭解適用兒童保護裝置的座椅位置。

Review your vehicle owner's manual for seating locations.

- 為了確保嬰幼兒的乘車安全，建議將本產品安裝於車輛後方的座位上。

In order to guarantee baby's riding safety, it is suggested that this product is installed on back passenger seat.

- 請安裝在座椅最後方的位置以防止因安全氣囊的爆開所造成的傷害。

Please install it on the very end vehicle seat to prevent the harm caused by the explosion of airbag.

危險
Danger

- 請勿安裝於無法確實固定的座椅上。
- 請勿安裝於車輛安全帶有破損的座椅上。
- Please do not install it on a seat that cannot actually affix the product.
- Please do not install it on a seat with a damaged seat belt.

〈安裝場所的要求

Requirement of installation location〉

- ① 請選擇在可以將車門全部敞開、寬廣且平坦的場所進行安裝作業。

Choose a spacious and flat place that all car doors can be opened to proceed on the installation.

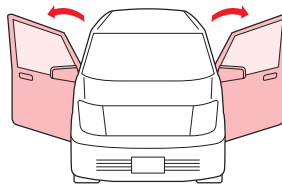

- ② 進行安裝作業前，必須確保車輛的前方座椅能夠往前倒，並且能向前移動才可進行安裝作業。

Before installation, make sure the front seat can be put down, and can be moved forward.

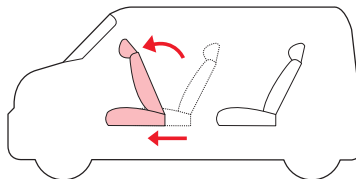

危險的車輛座椅位置 Unsafe Vehicle Seat Locations



〈請勿將本產品安裝於以下任一車輛座席位置：

Never install this car seat in any of the following vehicle seating locations:〉

- 1 車輛座椅為後向式或側向式的車輛座椅位置。
Rear-facing or side-facing vehicle seats.
- 2 使用後向模式時，正面設有安全氣囊的車輛座椅。
Rear-facing with an active front air bag.
- 3 使用輔助座椅模式時，僅配備有腰部安全帶的車輛座椅。
booster mode with vehicle lap only seat belt

警告
WARNING

- 使用方式錯誤時，可能會造成使用者死亡或重傷等情形。
Improper use may lead to severe injury or even death of the user.
- 請詳閱車主手冊，瞭解適用兒童保護裝置的座椅位置。
Review your vehicle owner's manual for seating locations.

危險的車輛座椅位置 Unsafe Vehicle Seat Locations



〈無法安裝本產品的車輛座椅 Vehicle seat on which this product cannot be installed〉

- 汽車座椅與孩童保護裝置之間，不應因為汽車座椅頭枕而出現空隙。
SHOULD NOT create a gap between vehicle seat and booster seat.
- 孩童保護裝置的底座前端不得超出汽車座椅的前端，而導致呈現懸空狀態。
The front of booster seat base MUST NOT hang over front of vehicle seat.
- 若孩童無法接受使用汽車安全帶，請勿使用此孩童保護裝置。
If child will not keep the vehicle seat belt properly positioned, DO NOT use this booster seat.

警告 WARNING

- 使用方式錯誤時，可能會造成使用者死亡或重傷等情形。
Improper use may lead to severe injury or even death of the user.
- 請詳閱車主手冊，瞭解適用兒童保護裝置的座椅位置。
Review your vehicle owner's manual for seating locations.

車輛安全帶的條件 Vehicle seat belt condition

〈車輛安全帶種類 Car seat belt category〉

- 此兒童保護裝置僅適用符合台灣CNS11497及ECE R44/04基準或等效標準之3點式車輛安全帶之車輛座椅使用。

This child restraint system for vehicles is used with car seat belt fixing system, and meets the standards of CNS11497 and ECE R44/04 in Taiwan. This is categorized as “General Type” child restraint system for vehicles.

- 本產品為「通用型」及「半通用型」的汽車用兒童保護裝置。

This is a “Universal” or “semi-universal” child restraint system for vehicles.

- 確認車輛座椅的安全帶種類後，再進行安裝本兒童安全裝置。

If vehicle manufacturer states in the user manual that the general type for child protecting device is applicable to the car, then this device can be installed in this vehicle correctly.

安全帶的種類		安全帶的特徵	安裝時請注意
3-點式安全帶	ELR式安全帶 (緊急鎖定捲收器)	通常車輛安全帶可自由伸縮，若遇到急煞車、衝撞等緊急狀況時才上鎖。	緩緩拉出車輛安全帶後使用。
	ALR/ELR式安全帶 (自動鎖定捲收器)	車輛座椅安全帶拉出後在任何長度停止隨即自動上鎖型的捲收裝置。	拆卸本產品時，收回全部的車輛安全帶即可解除鎖定捲收器。
	其他	不符合上述條件的安全帶。	不適用安裝本產品。

Category of seat belt		Features	Notice in installation
3-point seat belts	ELR-type seat belt (Urgency locking retractor)	Seat belt in the car is retractable, but is locked when urgent brake or collision happens.	Slowly pull out seat belt and then use it.
	ALR/ELR-type seat belt (Automatic locking retractor)	The retractor will automatically lock the seat belt at any length when the pulling stops.	To remove this product, retrieve all of the seat belt to unlock the locking retractor.
	Others	Seat belt that does not meet any description above.	Not suitable for installing this product.

車輛安全帶的條件 Vehicle seat belt condition

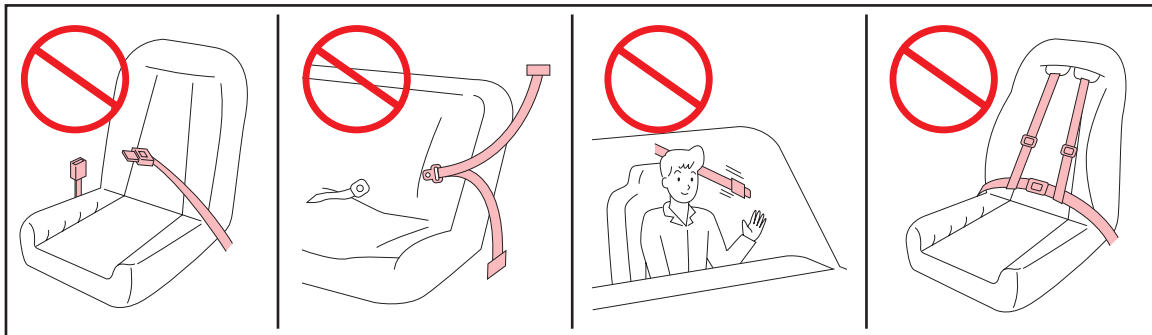

〈無法安裝本產品於以下種類的車輛安全帶：

This product cannot be installed with the following seat belt:〉

- 兩點式安全帶座椅。2-point seat belt.
- 座椅安全帶為上下共捲式。Seat belt is retracted by both top and bottom sides.
- 車輛的座椅安全帶為全自動裝置。Seat belt is installed with an automatic device.
- 配備市售賽車或跑車等特定目的的安全帶座椅。Seat belt is equipped on a special purpose seat, such as racecar or sports car.

警告
WARNING

- 使用方式錯誤時，可能會造成使用者死亡或重傷等情形。
Improper use may lead to severe injury or even death of the user.
- 請詳閱車主手冊，瞭解適用兒童保護裝置的座椅位置。
Review your vehicle owner's manual for seating locations.

安裝座椅條件 Conditions of vehicle seat

質量等級 Quality grade	適用體重 Weight	安裝方式 Installation mode	適用車輛安裝方式 How to Instal
質量等級0+ Group 0+	0kg起~13kg以下 from 0kg to 13kg	後向安裝 Rear-Facing	車用三點式安全帶 using 3-point belt only
質量等級 I Group I	13kg以上~18kg以下 from 13kg to 18kg	前向安裝 Forward-Facing	車用三點式安全帶+ISOcatch 車用三點式安全帶 using ISOcatch System and 3-point belt or using 3-point belt only
質量等級 II、III Group II、III	15kg以上~36kg以下 from 15kg to 36kg	輔助座椅模式 Booster Mode	車用三點式安全帶+ISOcatch 車用三點式安全帶 using ISOcatch System and 3-point belt or using 3-point belt only

 **警告**
WARNING

- 請務必使用車用三點式安全帶+ISOcatch安裝，請勿僅使用ISOcatch安裝。
Installation using ISOcatch System and 3-point belt or using 3-point belt only
(Please do not install using ISOcatch System only)
- 若車輛無配備ISOFIX裝置時，請使用車用安全帶安裝，請參閱P18。
Please installation using 3-point belt if your car without ISOFIX system, See P18.

縫製品的拆卸方法 Disassembling method for sewing products

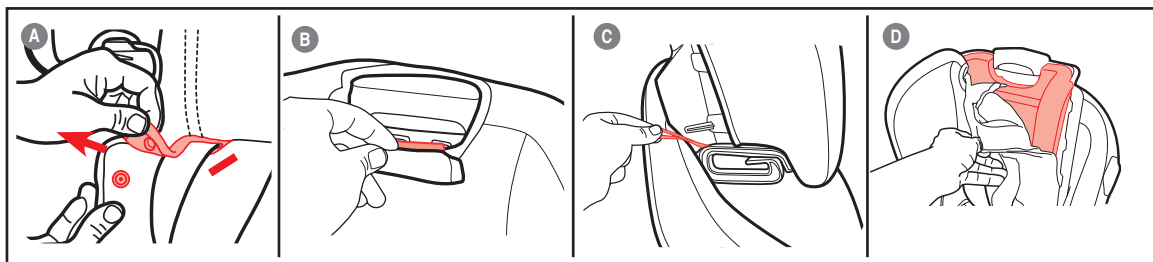

〈護頭枕套 Headrest Pad〉

若有需要，可將頭枕靠墊拆下清洗。If needed, headrest pad may be removed for cleaning.

Ⓐ需拆下時，請解開護頭枕套上的固定扣，再將肩帶抽出。

To remove, unsnap the pad to pull the harness straps out.

Ⓑ將位於高度調節鈕附近的塑膠固定片拉出溝槽口。

Pull the plastic tab out of the slots just below the red adjustment handle.

Ⓒ取下護頭枕兩側勾環的鬆緊帶。

Remove the elastic straps from the hooks on both sides of the headrest.

Ⓓ將整塊護頭枕套取下。Pull pad off of headrest.

※安裝時，請依據上述步驟之相反順序操作。Reverse the steps to reattach the cover on the headrest.



注意
CAUTION

以冷水機洗時，建議放入洗衣袋中，並以低速弱洗程序洗滌。並請平放自然風乾，請勿使用漂白水。

Machine wash cover in cold water on delicate cycle and drip-dry. DO NOT USE BLEACH.

縫製品的拆卸方法 Disassembling method for sewing products

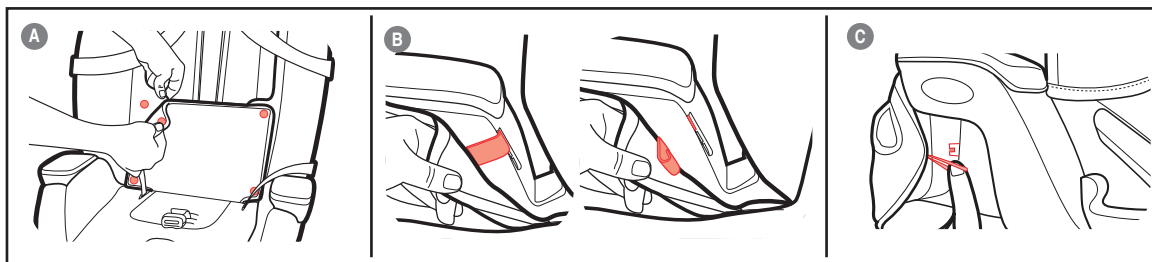

〈座椅墊 Lower Seat Pad〉

若有需要，可將座椅墊拆下清洗。If needed, lower seat pad may be removed for cleaning.

Ⓐ需拆下時，先將腰側的固定扣解開。

To remove, unsnap lower seat pad from side pad.

Ⓑ解開扶手上的塑膠勾環。

Undo the plastic hooks on both armrest.

Ⓒ從扶手取下鬆緊帶。將座椅墊取下。

Unhook the elastic strap from both armrests. Pull the pad off.

※安裝時，請依據上述步驟之相反順序操作。Reverse the steps to reattach the cover on the headrest.



注意
CAUTION

以冷水機洗時，建議放入洗衣袋中，並以低速弱洗程序洗滌。並請平放自然風乾，請勿使用漂白水。

Machine wash cover in cold water on delicate cycle and drip-dry. DO NOT USE BLEACH.

縫製品的拆卸方法 Disassembling method for sewing products

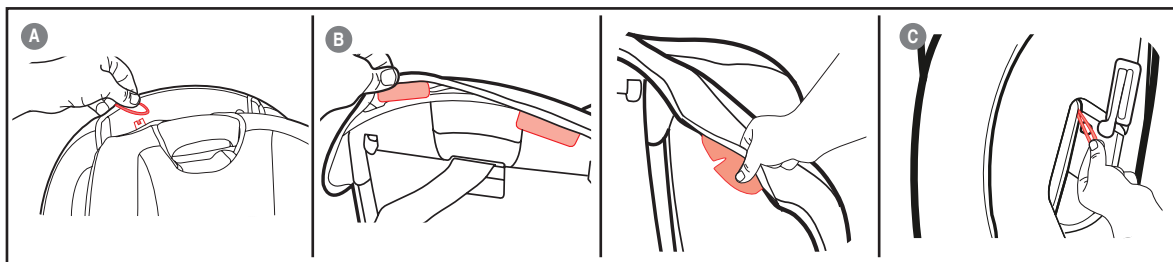

〈側邊防護墊 Side Pad〉

若有需要，可將側邊防護墊拆下清洗。 If needed, side pad may be removed for cleaning.

- Ⓐ 需拆下時，請將護頭枕調至最低段，由護頭枕後方解開側邊防護墊的鬆緊帶。
To remove, lower headrest and unhook the pad from back.
- Ⓑ 從後方及座椅兩側拉出塑膠固定片。
Pull the plastic tabs out from the back and sides of the seat.
- Ⓒ 取下前向安裝安全帶溝槽勾環的鬆緊帶。將側邊防護墊取下。
Remove the elastic straps from the hooks in the forward-facing belt path. Pull the pad off.

※安裝時，請依據上述步驟之相反順序操作。 Reverse the steps to reattach the cover on the headrest.



注意
CAUTION

以冷水機洗時，建議放入洗衣袋中，並以低速弱洗程序洗滌。並請平放自然風乾，請勿使用漂白水。

Machine wash cover in cold water on delicate cycle and drip-dry. DO NOT USE BLEACH.

縫製品的清潔方式 Cleaning ways for Sewing product

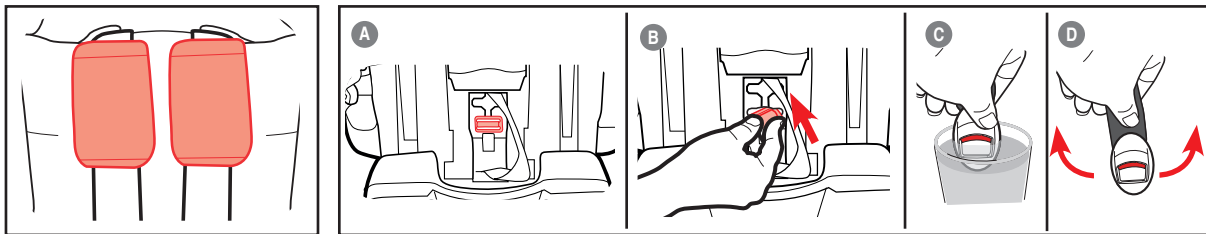

〈肩帶保護套 Harness Covers〉

清洗肩帶保護套：請使用濕布擦拭乾淨。Cleaning Harness Covers: Wipe clean with damp cloth.

〈股帶固定扣 Crotch Buckle〉

清潔股帶固定扣：Cleaning Crotch Buckle:

- Ⓐ 調整座椅的傾斜角度，找出固定金屬片。Recline the car seat and locate the metal retainer.
- Ⓑ 將固定金屬片向上轉，穿過椅殼和椅墊，然後從正面拉出股帶固定扣。
Rotate the metal retainer up through the shell and pad. From the front, pull the crotch buckle out.
- Ⓒ 清潔固定扣時，請將其放入裝有溫水的杯內，輕輕攪動固定扣，並在水中按壓紅色扣鈕數次。
To clean buckle, place in a cup of warm water and gently agitate the buckle. Press the red button several times while in the water.
- Ⓓ 將多餘的水甩出，使其風乾，並視需要重複此步驟，直至扣上時可發出清脆的喀擦聲為止。將固定扣裝回插扣槽的方式與拆除方式相同，裝上後將股帶固定扣往上拉，並確認已安裝牢固。
Shake out excess water and allow to air dry. Repeat steps as needed until it fastens with a click. Re-insert the buckle into the same slot it was removed. Pull up on crotch buckle to make sure it is secured.

平日保養 Standard maintenance

〈座椅縫製品清洗方法 Cleaning ways for seat sewing product〉



注意 CAUTION

- 請勿與其他物品一起洗滌，因恐顏色轉染的問題發生。
- Please do not wash it with other objects to avoid color-staining problems.
- 建議放入洗衣袋中，洗衣機水溫設定40度以下，並以低速弱洗程序清洗。
- When washing with the washing machine, it is recommended that a wash bag is used and the washing mode is set to low speed delicate cycle.

〈主體塑膠部位的保養方法 Maintenance on plastic parts of main frame〉

〈當有灰塵吸黏住時 When it is attached by dust〉

- 請使用柔軟的乾布輕輕擦拭。Please wipe it gently with a soft dry cloth.
- 請勿讓可動部位周圍囤積灰塵或紙屑，仔細地用吸塵器將灰塵或紙屑清除乾淨。Please do not accumulate dirt or paper scrap around the movable part, and carefully remove dirt or paper scrap with a vacuum cleaner.

〈水溶性的髒污（果汁、口水等）Water soluble smudge (juice or saliva)〉

- 請以柔軟的布浸於水溫約40度的溫水中後稍微捲乾再擦拭。Please use a soft wet cloth, submerged in 40 degrees warm water and dried out slightly, to wipe.
- 安全帶、守護墊類請在陰涼處陰乾。Dry the seat belt and protecting pad in shade place.

〈非水溶性的髒污（牛奶、油脂、美乃滋等）Non-water-soluble smudge (milk, fat, or mayonnaise)〉

- 請以柔軟的布浸於加入中性洗潔劑水溫約40度的溫水中之後稍微擰乾再擦拭。擦拭後再以沾有冷水或溫水的布把中性洗潔劑擦拭乾淨。Please use a soft wet cloth, submerged in 40 degrees warm water with neutral detergent and slightly dried, to wipe first, and then use a cold or warm web cloth to wipe out the neutral detergent.
- 清潔肩帶時僅可使用中性肥皂與濕布進行表面清潔。請勿將肩帶浸泡於水中，以免導致減弱肩帶的固定效能。Dry the seat belt and protecting pad in shade place.

注意 CAUTION

- 請勿使用造成座椅以及附屬品變形、變色、劣化的稀釋劑等的溶劑。
- Please do not use solvent such as diluents to cause deformation, color changing and degradation for the seat and accessory appendages.

保管·廢棄方法 Custody · abandon method

〈保管方法 Custody method〉

- 請將說明書妥善存放在有說明書圖示的收納槽內（如圖所示）。
Store instruction manual in the slot with the instruction book icon as shown.
- 收藏時請將本產品以大型塑膠袋套入，放置在於灰塵少並且不會日曬的場所保管。
Put this product inside a big plastic bag and place it in a location with less dust and without sunlight for storage.
- 再度使用時，若發現本體有破損、異常時，為了嬰幼兒安全起見，請停止使用本產品。
When reusing it, if any damage or abnormality is discovered on the main frame, please stop using this product for the sake of the baby's safety.

 注意 CAUTION	<ul style="list-style-type: none">· 請勿放置於屋外或遭受雨淋。（因恐劣化，將使性能無法充分發揮）。· Please do not place this product outdoors to make it worn from rain (since this could cause degradation and make it unable to fulfill functions).
---	---

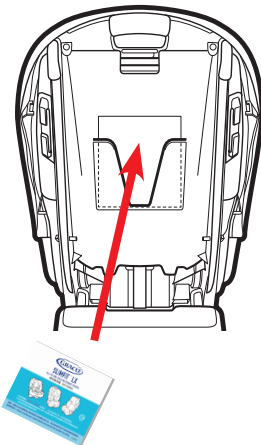

〈背面圖 Back view〉

〈廢棄方法 Abandon method〉

- 若是因發生事故須報廢時，將本產品用麥克筆標記「事故品」註明。
If this product needs to be abandoned due to an accident, mark "Discarded product" on this product with a permanent marker.
- 為了我們所居住的地球自然環境著想，請勿隨意丟棄。請按照廢棄物處理的相關規定將本產品分類處理。
For the consideration of the natural environment we live in, please do not randomly discard this product. Please follow the related stipulation of waste disposal to apply corresponding classified process.

保固事宜

〈保固事宜〉

- 於品質保證期間內（自購買日起1年內），由於零件短少、加工不良等可歸責於本公司者、依照使用說明書及注意事項而在正常使用狀態下故障者，根據保固規定提供免費修繕服務。

自購買日起已超過3年之產品，雖仍受理修理，但產品修理部位以外之品質，則恕不保證。

此外，已停產之產品，可能因修理所需零件已無庫存而無法修理。（零件之保有期間為停產後3年期間。即使於3年內，零件之顏色、布料之花樣等方面，亦有可能無法符合您所指定的，敬請見諒。）

〈售後服務事宜〉

- 使用中發生故障等情況，或檢查中發現時，需要更換零件或修理時，各部位之固定部位發生鬆動或異音、零件缺損及感覺到其他異常時，請停止使用，並確認產品名稱、品番、批號（參考下圖）後，向購買的進口商聯絡。

品名、品番、批號

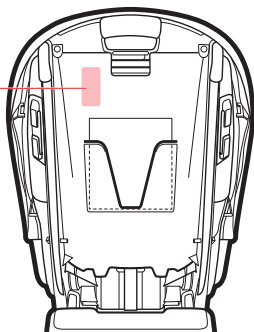

〈座椅背部〉

- 聯絡時，請務必告知本產品座椅下方之品名、品番、批號，以利溝通。

適用車輛

此兒童保護裝置被歸類為半通用型，適用下述車輛座椅位置之安裝。

品牌	年式	款式	車種	安裝位置	安裝方式
TOYOTA	2015～	Previa	2.4 /3.5	後座左右	ISO catch+車用安全帶
TOYOTA	2015～	Prius	1.8E/1.8G/1.5	後座左右	ISO catch+車用安全帶
TOYOTA	2015～	Vios	雅緻	後座左右	ISO catch+車用安全帶
TOYOTA	2015～	Wish	2.0	後座左右	ISO catch+車用安全帶
HONDA	2015～	CR-Z	1.5	後座左右	ISO catch+車用安全帶
NISSAN	2015～	Juke	1.6	後座左右	ISO catch+車用安全帶
NISSAN	2015～	Rogue	2WD /AWDi	後座左右	ISO catch+車用安全帶
NISSAN	2015～	Teana	2.0/2.5	後座左右	ISO catch+車用安全帶
NISSAN	2015～	X-Trail	2.0/2.5	後座左右	ISO catch+車用安全帶
MITSUBISHI	2015～	Lancer	Fortis 1.8 iO 1.8 iO 2.0	後座左右	ISO catch+車用安全帶
LUXGEN	2015～	M7 Turbo	全系列	後座左右	ISO catch+車用安全帶
MAZDA	2015～	3/5/6	全系列	後座左右	ISO catch+車用安全帶
LEXUS	2015～	LS/GS/ES	全系列	後座左右	ISO catch+車用安全帶

- 其他車輛型式亦有可能適用此兒童保護裝置。如有疑問，請洽兒童保護裝製造商或經銷商。
- 後向安裝時，不得使用於裝置安全氣囊之車輛座椅位置。

MEMO

MEMO

保 證 書



〈僅適用台灣地區〉

〈保固規定〉

- 1 消費者請於購買時要求經銷商在本保證書上蓋章，並填上銷售日期或將保固貼紙貼上。
 - 2 本公司產品之保固期間為自購買日起一年間。
 - 3 產品在保固期間內需要維修服務時，請出示本保證書。
 - 4 產品維修前，未出示本產品保證書或保證書尚未蓋店章、未填寫銷售日期時，即使於一年內購買，亦無法享有一年保固之免費修繕服務。
 - 5 於品質保證期間內，由於零件短缺、加工不良等進口商所引起之原因，由進口商提供免費修繕服務（含運費）。若為消費者之責任，則計費維修。
 - 6 免費修繕服務不包含以下項目。
 - ◎ 非歸責於進口商責任之任何損壞與故障。
 - ◎ 坐墊、縫製品等刮傷。
 - ◎ 使用者任意變更所引起。
 - ◎ 由自然災害或事故等原因所引起。
 - ◎ 框架自然劣化（塗料部分需時常保養）。
 - ◎ 錯誤的使用方法或保養不良所致。
- 使用時，如發生故障或強烈撞擊、不慎掉落等情況及發現有零件需要更換時，台灣地區請向本公司維修中心聯絡，海外地區請洽當地代理商聯絡，我們竭誠為您服務。
- 請確認購買時之經銷商店名稱，填寫型號、購買日期。
 - 本保證書不另行補發，因此請小心保管，避免遺失。
 - 本保證書填寫之個人資料，僅使用於產品保固及修理事宜。

產品	SLIMFIT™ LX		
型號		購買日期	
顧客資料	姓名		
	地址		
	電話		
	E-mail		
經銷商 確認章			
(請務必蓋章或將保固貼紙貼於此處，保證方為有效)			

委製商：

Newell Rubbermaid Asia Pacific Limited

40/F, Manhattan Place 23 Wang Tai Road, Kowloon Bay
Kowloon, Hong Kong
TEL : +852-2195-2695

進口商：

台灣愛普力卡股份有限公司

總公司營業部 地址：新竹縣竹北市台元街28號5樓之3
電話：(03)552-5688 傳真：(03)552-5690

維修服務中心 地址：新竹縣竹北市福興路885號
電話：(03)656-1261 傳真：(03)656-1267

信箱：0800@aprica.com.tw 統一編號：22662003